

Article number: 0107052

Description: Retaining ring AK 35 DIN 983

Measures

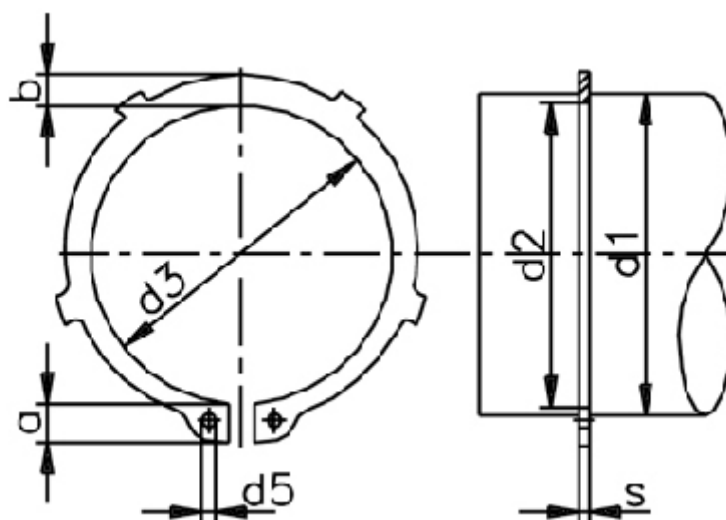

a max	= 5.2	FN kN	= 17.80	Number of serrations	= 6
AN mm ²	= 106.0	FRg kN	= 5.5	s	= 1.50
b	= 3.8	FR kN	= 30.8	t	= 1.00
d1	= 35	g	= 2.0	tol	= -0.25
d2	= 33.0	K kN-mm	= 60.1	tol	= -0.06
d3	= 32.2	m min	= 1.60	tol	= +0,25-0,50
d5 min	= 2.5	n abl x 1000	= 15	Tong	= ZGA-2
Description	= AK 35	Nominal drive	= 3.0	Weight kg/1000	= 4.38